

TMR7504-B

Unibody Low Temperature-Drift Current Sensor

Description

TMR7504-B is an open loop current sensor for accurate measurement of DC, AC, pulsed current and arbitrary waveform current with galvanic isolation between primary and secondary circuits.

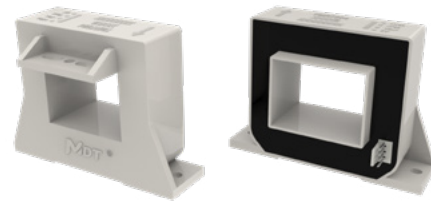

Features and Benefits

- Low temperature drift
- Galvanic isolation
- High immunity to external interference

Applications

- DC motor drives
- Inverter and variable frequency drives (VFD)
- Uninterruptible power supplies (UPS)
- Power supplies for welding application
- Switching power supplies

Selection Guide

Model	Primary Nominal Current	Primary Current Measuring Range
TMR7504-2000B	200 A	±600 A
TMR7504-4000B	400 A	±1200 A
TMR7504-5000B	500 A	±1500 A
TMR7504-6000B	600 A	±1800 A
TMR7504-8000B	800 A	±2400 A
TMR7504-1001B	1000 A	±2500 A
TMR7504-1201B	1200 A	±2500 A
TMR7504-1501B	1500 A	±2500 A

Insulation and Environmental Characteristics

Parameters	Symbol	Typical	Unit
Dielectric Strength	V_D	5	kV(50Hz, 1min)
Insulation Resistance	R_{IS}	1000	MΩ
Creepage Distance	d_{CP}	15	mm
Clearance	d_{CL}	7	mm
Ambient Operating Temperature	T_A	-40 to +105	°C
Ambient Storage Temperature	T_{STG}	-40 to +105	°C
Mass	m	320	g

Catalogue

1. Specifications	03
2. Typical Output Characteristics.....	04
3. Typical Temperature Characteristics	05
4. Parameters Definition And Formula.....	08
5. Application Information	09
6. Dimensions	10

1. Specifications

$T_A = +25\text{ }^\circ\text{C}$, $V_{CC} = \pm 15\text{ V}$, $R_L = 10\text{ k}\Omega$, unless otherwise noted

Parameter	Symbol	Conditions	Min.	Typ.	Max.	Unit	
General Electrical Data							
Primary Nominal Current	I_{PN}	TMR7504-2000B	-	200	-	A	
		TMR7504-4000B	-	400	-		
		TMR7504-5000B	-	500	-		
		TMR7504-6000B	-	600	-		
		TMR7504-8000B	-	800	-		
		TMR7504-1001B	-	1000	-		
		TMR7504-1201B	-	1200	-		
Primary Current Measuring Range	I_{PM}	TMR7504-2000B	-600	-	600	A	
		TMR7504-4000B	-1200	-	1200		
		TMR7504-5000B	-1500	-	1500		
		TMR7504-6000B	-1800	-	1800		
		TMR7504-8000B	-2400	-	2400		
		TMR7504-1001B	-2500	-	2500		
		TMR7504-1201B	-2500	-	2500		
Sensitivity	S	$I_P = 0\text{ to } \pm I_{PN}$	TMR7504-2000B	-	20.00	-	mV/A
			TMR7504-4000B	-	10.00	-	
			TMR7504-5000B	-	8.00	-	
			TMR7504-6000B	-	6.67	-	
			TMR7504-8000B	-	5.00	-	
			TMR7504-1001B	-	4.00	-	
			TMR7504-1201B	-	3.33	-	
Output Voltage	V_{OUT}	$I_P = 0\text{ to } \pm I_{PM}$	-	$V_{OE} + S \times I_P$	-	V	
Supply Voltage	V_{CC}	$\pm 5\%$	-	± 15	-	V	
Current Consumption	I_C	$I_P = 0$	-	+25/-5	-	mA	
Load Resistance	R_L	$I_P = 0\text{ to } \pm I_{PN}$	1	10	-	k Ω	
Load Capacitance	C_L	$I_P = 0\text{ to } \pm I_{PN}$	-	100	-	pF	
Static Performance Data							
Accuracy	X_G	$T_A = +25\text{ }^\circ\text{C}$, $I_P = 0\text{ to } \pm I_{PN}$	-1	± 0.5	1	% I_{PN}	
		$T_A = -40\text{ }^\circ\text{C to } +40\text{ }^\circ\text{C}$, $I_P = 0\text{ to } \pm I_{PN}$	-2	± 0.5	2		
		$T_A = +40\text{ }^\circ\text{C to } +85\text{ }^\circ\text{C}$, $I_P = 0\text{ to } \pm I_{PN}$	-3	-	1		
		$T_A = +85\text{ }^\circ\text{C to } +105\text{ }^\circ\text{C}$, $I_P = 0\text{ to } \pm I_{PN}$	-4.5	-	1		
Linearity Error	ϵ_L	$T_A = -40\text{ }^\circ\text{C to } +105\text{ }^\circ\text{C}$, $I_P = 0\text{ to } \pm I_{PN}$	-	± 0.2	-	% I_{PN}	
Symmetry	ϵ_{SYM}	$T_A = -40\text{ }^\circ\text{C to } +105\text{ }^\circ\text{C}$, $I_P = 0\text{ to } \pm I_{PN}$	99	100	100	%	
Sensitivity Error	ϵ_S	$T_A = -40\text{ }^\circ\text{C to } +105\text{ }^\circ\text{C}$, $I_P = 0\text{ to } \pm I_{PN}$	-4	-	1.5	%	
Offset Error	V_{OE}	$T_A = +25\text{ }^\circ\text{C}$, $I_P = 0$	-20	± 10	20	mV	
		$T_A = -40\text{ }^\circ\text{C to } +85\text{ }^\circ\text{C}$, $I_P = 0$	-35	± 20	35		
		$T_A = +85\text{ }^\circ\text{C to } +105\text{ }^\circ\text{C}$, $I_P = 0$	-40	± 20	40		
Hysteresis	V_{OH}	$I_P = \pm I_{PN} \rightarrow 0$	-10	± 5	10	mV	
Dynamic Performance Data							
Response Time	t_R	$di/dt > 50\text{ A}/\mu\text{s}$, 10% to 90% of I_{PN}	-	5	-	μs	
Bandwidth	BW	-3 dB	DC	25	-	kHz	

2. Typical Output Characteristics

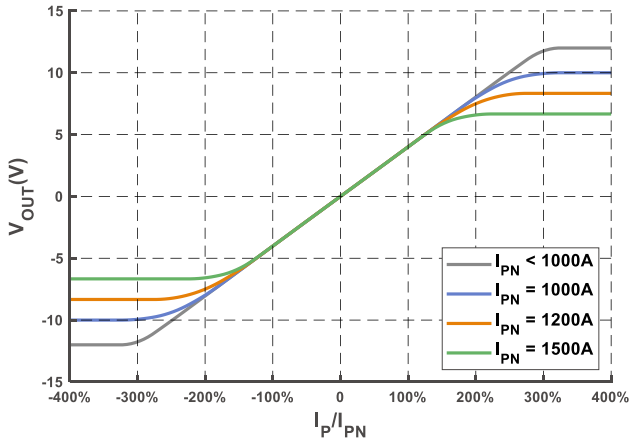

Figure 1. Output Voltage vs Primary Current

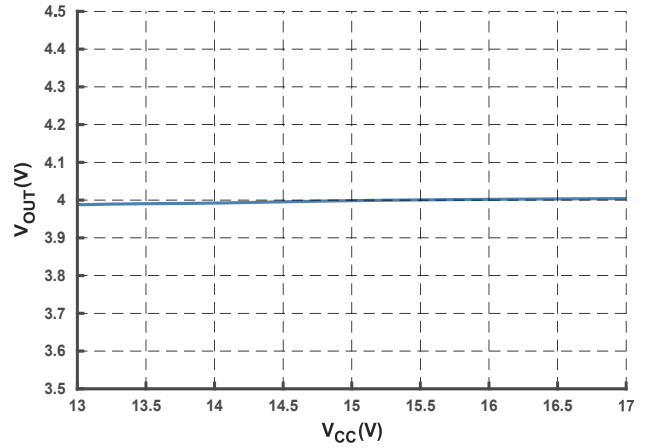

Figure 2. Output Voltage vs Supply Voltage (@ $I_P = I_{PN}$)

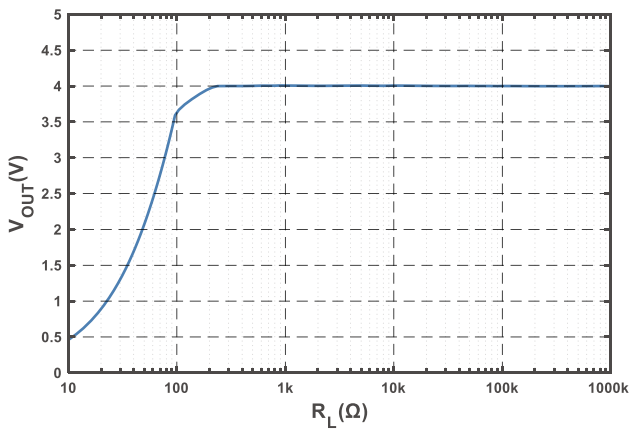

Figure 3. Output Voltage vs Load Resistance
(@ $I_P = I_{PN}$)

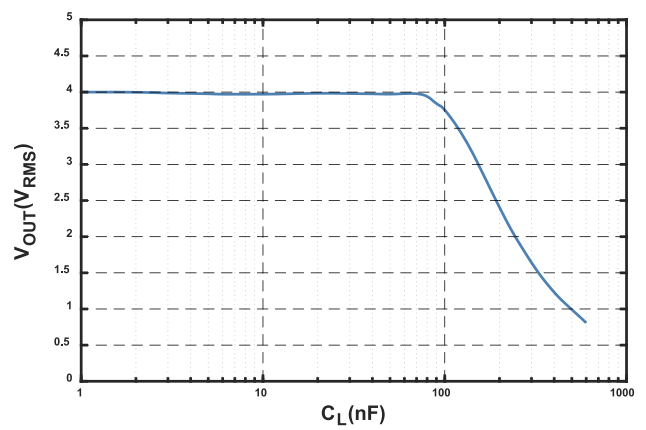

Figure 4. Output Voltage vs Load Capacitance
(@ $I_P = I_{PN}$)

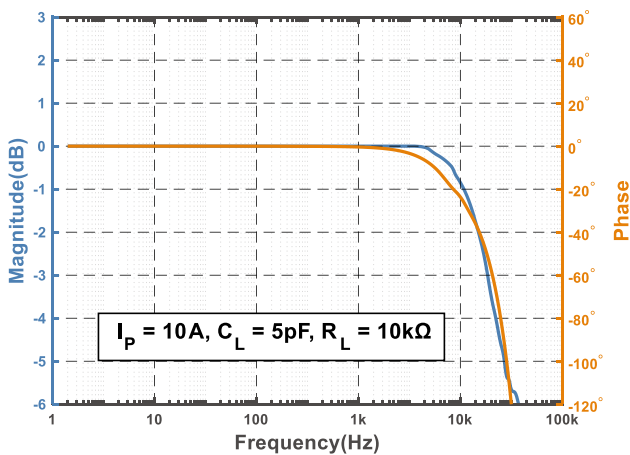

Figure 5. Bode Plot

3. Typical Temperature Characteristics

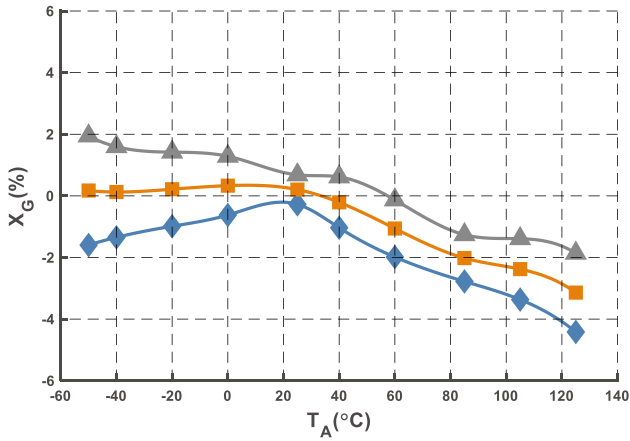

Figure 6. Accuracy

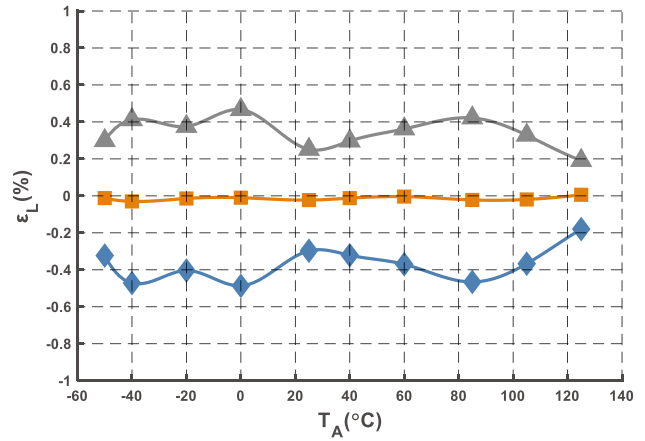

Figure 7. Linearity Error

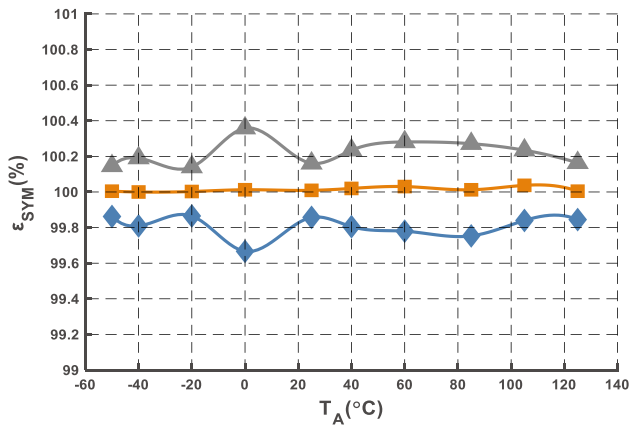

Figure 8. Symmetry

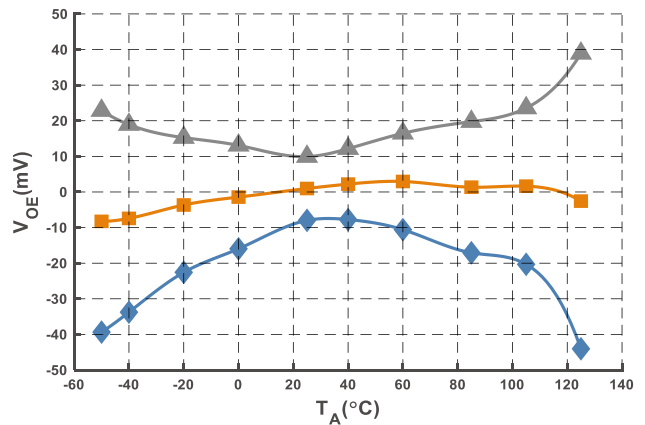

Figure 9. Offset Error

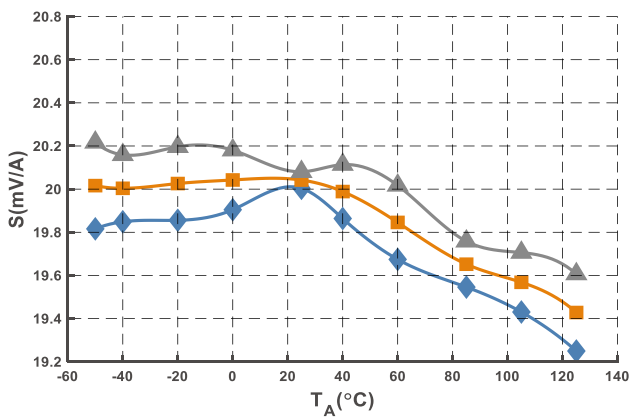

Figure 10. Sensitivity (@ $I_{PN} = 200$ A)

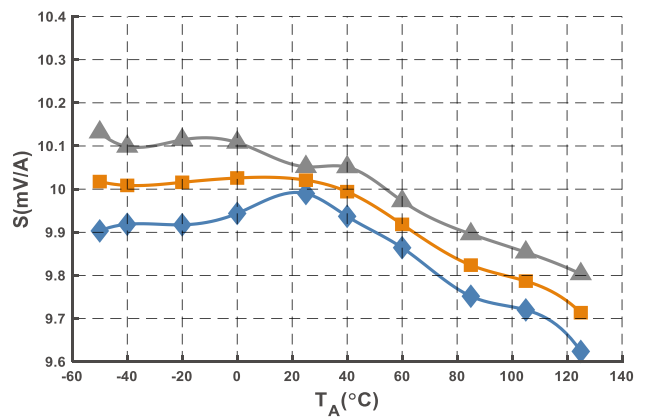

Figure 11. Sensitivity (@ $I_{PN} = 400$ A)

Typical Temperature Characteristics

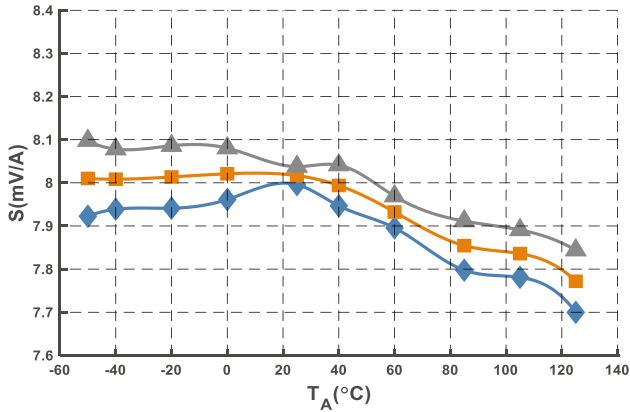

Figure 12. Sensitivity (@I_{PN} = 500 A)

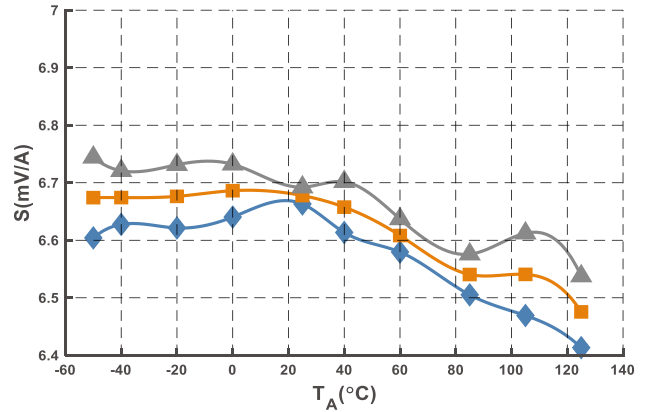

Figure 13. Sensitivity (@I_{PN} = 600 A)

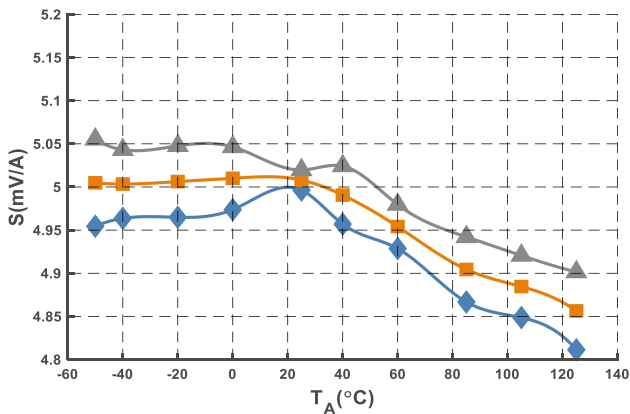

Figure 14. Sensitivity (@I_{PN} = 800 A)

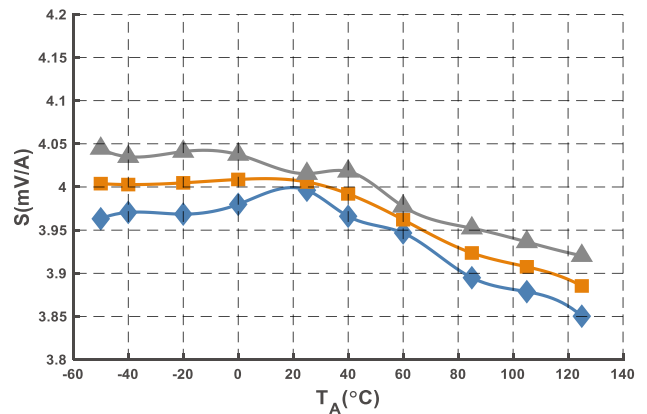

Figure 15. Sensitivity (@I_{PN} = 1000 A)

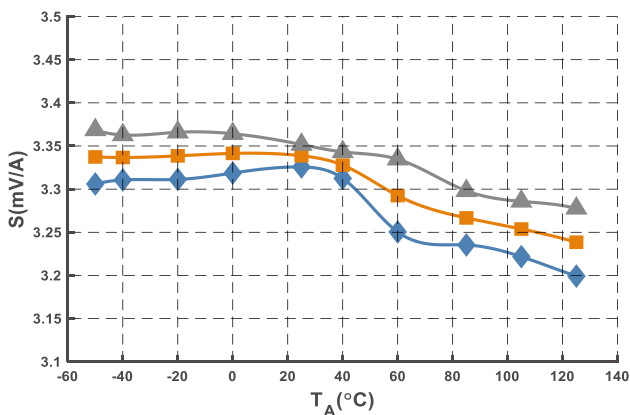

Figure 16. Sensitivity (@I_{PN} = 1200 A)

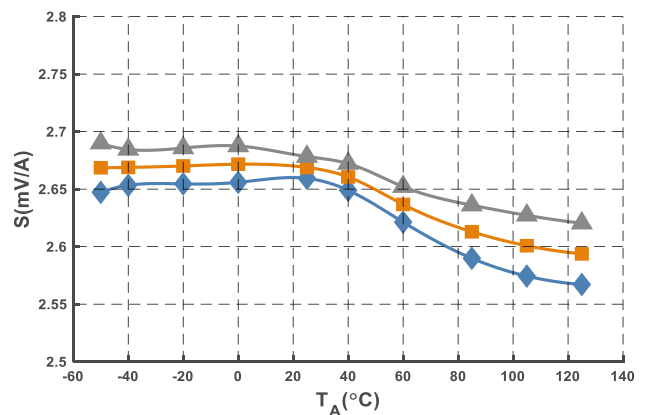

Figure 17. Sensitivity (@I_{PN} = 1500 A)

Typical Temperature Characteristics

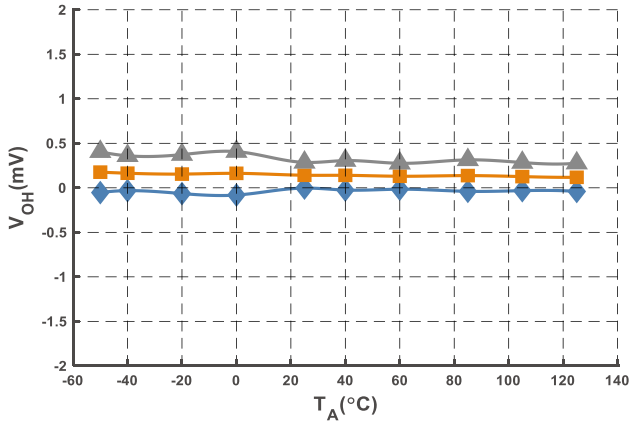

Figure 18. Hysteresis

4. Parameters Definition And Formula

1) Output Voltage

$$V_{OUT} = V_{OE} + S \times I_P$$

V_{OUT} stands for current sensor output voltage at given primary current, V_{OE} stands for offset error, S stands for sensitivity, I_P stands for primary current.

2) Accuracy

$$X_G = \text{MAX}_{I_P \in [-I_{PN}, I_{PN}]} \left(\frac{V_{OUT} - (S \times I_P)}{S \times I_{PN}} \times 100\% \right)$$

I_{PN} stands for nominal primary current.

3) Sensitivity

$$S = \frac{V_{OUT(@ I_{PN})} - V_{OUT(@ -I_{PN})}}{2 \times I_{PN}}$$

$V_{OUT(@ I_{PN})}$ and $V_{OUT(@ -I_{PN})}$ stand for the voltage output at I_{PN} and $-I_{PN}$ respectively.

4) Linearity

$$\varepsilon_L = \text{MAX}_{I_P \in [-I_{PN}, I_{PN}]} \left(\frac{V_{OUT} - (\bar{V}_{OE} + \bar{S} \times I_P)}{S \times I_{PN}} \times 100\% \right)$$

\bar{S} and \bar{V}_{OE} stand for the average values of the sensitivity and offset error.

5) Symmetry

$$\varepsilon_{SYM} = \left| \frac{V_{OUT(@ I_{PN})} - \bar{V}_{OE}}{V_{OUT(@ -I_{PN})} - \bar{V}_{OE}} \right| \times 100\%$$

6) Hysteresis

$$V_{OH} = \text{MAX } \Delta H$$

ΔH is the maximum residual voltage between full scale positive and negative nominal current.

5. Application Information

Electrical Connection

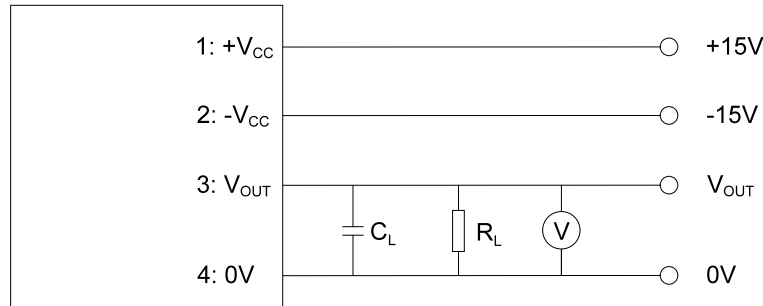

Figure 20. Electrical Connection

Mounting Recommendation

1. Mounting method:
 - 1 × Φ 4.5 mm hole and 1 × Φ 4.5 mm slotted hole
 - 2 × M4 copper or SS304 screws (Recommended torque 1.2 N·m)
 - Or
 - 1 × Φ 4.5 mm hole and 2 × Φ 4.5 mm slotted holes (Fixed to the busbar)
 - 3 × M4 copper or SS304 screws (Recommended torque 1.2 N·m)
2. Primary through hole dimensions: 40 mm × 30 mm
3. Secondary electrical connection:
 - Molex 22041041 (old PN: Molex 5045-04A)
 - Crimp Housing: Molex 22011042
 - Crimping Terminal: Molex 08500113

Remarks

1. V_{OUT} is positive when the primary current (I_p) is in the same direction as the arrow indication on the label and vice versa.
2. Improper connection may result in permanent damage of the sensor.
3. Excessive capacitive load may result in distortion of output signals when measuring high frequency primary signal. Please refer to Output Voltage vs Load Capacitance Curve.
4. Dynamic performances (di/dt and response time) are best with a single busbar completely filling the primary through hole.
5. Sensor is customizable upon request.

6. Dimensions

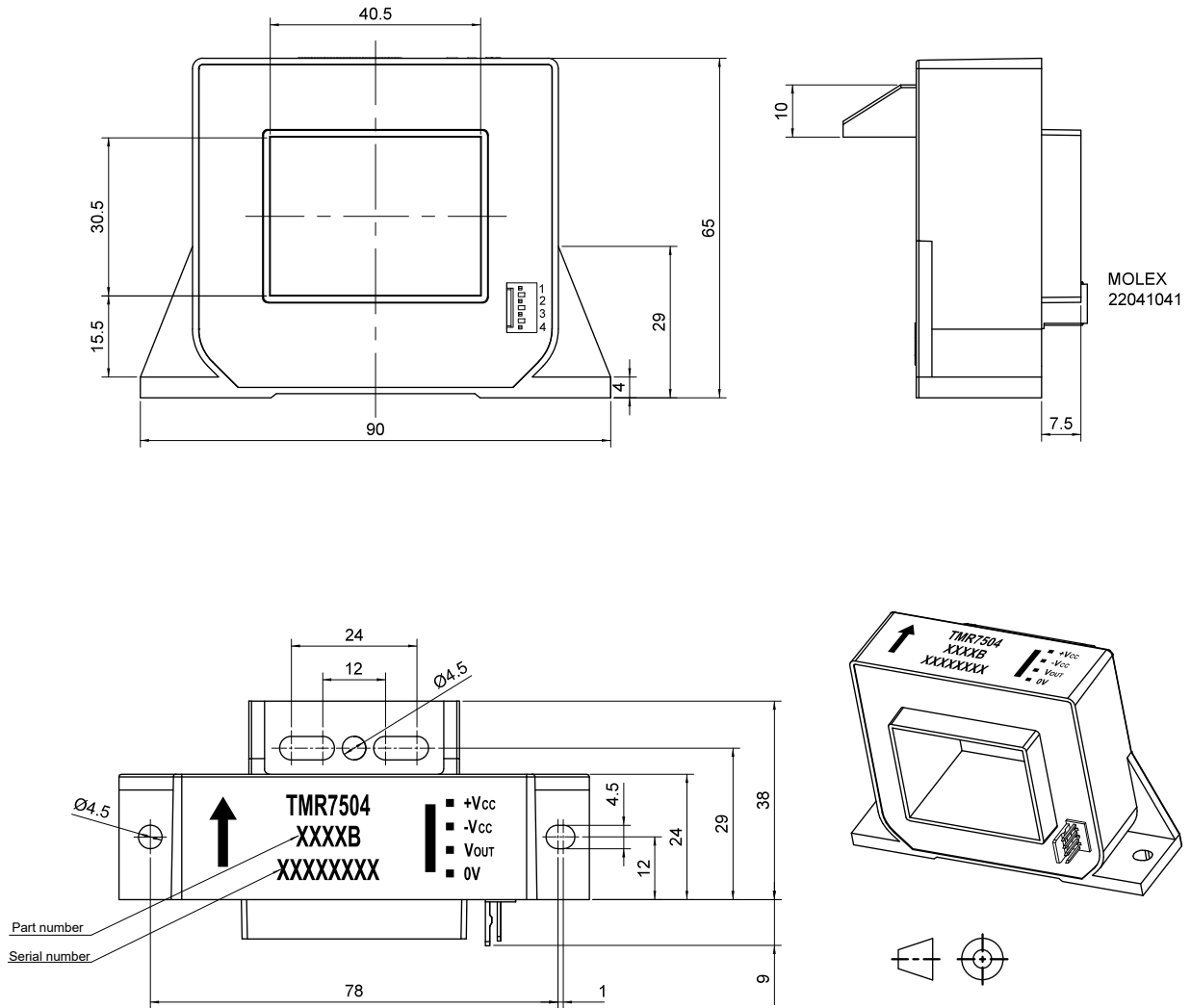

Figure 19. Dimension (unit: mm, tolerances for unmarked scales ± 1 mm)

Copyright © 2021 by MultiDimension Technology Co., Ltd.

Information furnished herein by MultiDimension Technology Co., Ltd. (hereinafter MDT) is believed to be accurate and reliable. However, MDT disclaims any and all warranties and liabilities of any kind, with respect to any examples, hints or any performance or use of technical data as described herein and/or any information regarding the application of the product, including without limitation warranties of non-infringement of intellectual property rights of any third party. This document neither conveys nor implies any license under patent or other industrial or intellectual property rights. Customer or any third-party must further determine the suitability of the MDT products for its applications to avoid the applications default of customer or third-party. MDT accept no liability in this respect.

MDT does not assume any liabilities of any indirect, incidental, punitive, special or consequential damages (including without limitation of lost profits, lost savings, business interruption, costs related to the removal or replacement of any products or rework charges) whether or not such damages are based on tort (including negligence), warranty, breach of contract or any other legal theory. Notwithstanding any damages that customer might incur for any reason whatsoever, MDT's aggregate and cumulative liability towards customer for the products described herein shall be limited in accordance with the terms and conditions of commercial sale of MDT.

Absolute maximum ratings are the extreme limits the device will withstand without damage to the MDT product. However, the electrical and mechanical characteristics are not guaranteed as the maximum limits (above recommended operating conditions) are approached. MDT disclaims any and all warranties and liabilities of the MDT product will operate at absolute maximum ratings.

Specifications may change without notice.

Please download latest document from our official website www.dowaytech.com/en.

Recycling

The product(s) in this document need to be handed over to a qualified solid waste management services company for recycling in accordance with relevant regulations on waste classification after the end of the product(s) life.



No.2 Guangdong Road, Zhangjiagang Free Trade Zone, Jiangsu, China

Web: www.dowaytech.com/en E-mail: info@dowaytech.com

