

TMR7307-C

Isolated, Wide Bandwidth, Open Loop TMR Current Sensor

Description

TMR7307-C series current sensor is a type of TMR based isolated, open loop current sensor. Benefits the wide bandwidth, it is suitable for measuring DC, AC, pulse and mixed types of current signals. The TMR7307-C series provides multiple current options as 20A, 25A, 32A, 40A, 50A. The through-hole structure and onboard type facilitates the wire insertion of MC4 like PV terminals, it is well suitable for the compact solar inverter applications.



Features and Benefits

- TMR sensing technology
- Fast response time: 1 μ s Typ.
- Wide bandwidth: 500 kHz Typ.
- Multiple current options: 20 A, 25 A, 32 A, 40 A, 50 A
- Fixed offset voltage and sensitivity
- Low temperature drift of offset voltage and sensitivity
- Galvanic isolation between primary and secondary circuits
- Through-hole onboard type, MC4 like terminal is compliant
- RoHS & REACH compliant

Applications

- AC variable speed drivers
- Solar inverter
- Combiner box
- Power supplies for welding
- Switching mode power supply (SMPS)

Selection Guide

Part Number	Sensitivity S (mV/A)	Supply voltage V_{CC} (V)	Offset voltage V_{OFF} (V)	Nominal current I_{PN} (A)	Measuring current I_{PM} (A)
TMR7307-20C	100	5	2.5	20	± 20
TMR7307-25C	80	5	2.5	25	± 25
TMR7307-32C	62.5	5	2.5	32	± 32
TMR7307-40C	50	5	2.5	40	± 40
TMR7307-50C	40	5	2.5	50	± 50

Catalogue

1. Pin Configuration	03
2. Typical Application Circuit.....	03
3. Environmental and Mechanical Characteristics.....	04
4. Isolation Characteristics	04
5. Absolute Maximum Ratings	04
6. Common Electrical Characteristics.....	05
7. TMR7307-20C Individual Electrical Characteristics	05
8. TMR7307-25C Individual Electrical Characteristics	06
9. TMR7307-32C Individual Electrical Characteristics	06
10. TMR7307-40C Individual Electrical Characteristics	07
11. TMR7307-50C Individual Electrical Characteristics.....	07
12. Typical Characteristics.....	08
13. Parameters Definition And Formula.....	09
14. Dimensions	10
15. Caution for Using.....	11

1. Pin Configuration

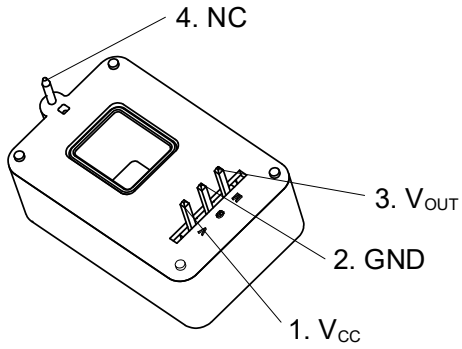

Pin Number	Symbol	I/O	Function
1	V _{CC}	P	Power supply
2	GND	P	Ground
3	V _{OUT}	AO	Analog output voltage
4	NC	-	No internal connection

Notes: AO – Analog output, P – Power supply

Figure 1. Pin configuration

2. Typical Application Circuit

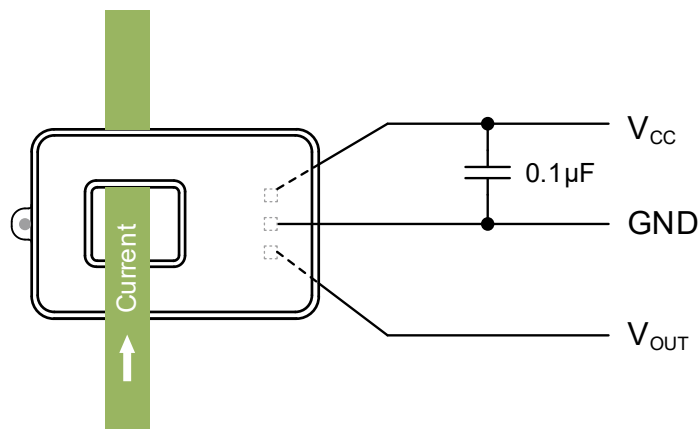

Figure 2. Typical application circuit

3. Environmental and Mechanical Characteristics

Parameter	Symbol	Min.	Typ.	Max.	Unit
Operating ambient temperature	T_A	-40	-	105	°C
Storage temperature	T_{STG}	-40	-	105	°C
Lead soldering temperature, 10sec	T_{LEAD}	-	-	260	°C
Mass	m	-	6	-	g

4. Isolation Characteristics

Parameter	Symbol	Value	Unit	Comment
Withstand isolation voltage	V_{ISO}	4	kV	AC 50 Hz/1min $V_{TEST} = V_{ISO}$, t = 60s (qualification) $V_{TEST} = 4.3$ kV, t = 10s (100% production)
Clearance	d_{CL}	8	mm	Shortest distance through air
Creepage distance	d_{CP}	8	mm	Shortest path along the body
Case material	-	UL 94-V0	-	-

5. Absolute Maximum Ratings

Parameter	Symbol	Min.	Max.	Unit	Comment
Supply voltage (not destructive)	V_{CC}	-0.3	6.5	V	V_{CC} - GND pin
Output voltage (not destructive)	V_{OUT}	-0.3	$V_{CC} + 0.3$	V	V_{OUT} - GND pin
ESD (Human body model)	V_{HBM}	4	-	kV	-

6. Common Electrical Characteristics

$T_A = 25\text{ }^\circ\text{C}$, $V_{CC} = 5\text{ V}$, $CV_{CC} = 0.1\text{ }\mu\text{F}$, $N_P = 1$ turn, Unless otherwise specified

Parameter	Symbol	Conditions	Min.	Typ.	Max.	Unit
Power Supply						
Supply voltage	V_{CC}	-	4.75	5	5.25	V
Current consumption	I_{CC}	-	-	3.5	5	mA
Power-on time	t_{ON}	$I_P = 0\text{ A}$, no load on V_{OUT}	-	0.1	-	ms
Analog Output						
Output impedance	Z_{OUT}	$f = 1\text{ Hz to }1\text{ kHz}$	-	1	-	Ω
Output load resistance	R_L	-	4.7	100	-	k Ω
Output load capacitance	C_L	No sustained oscillation	-	220	-	pF
Output voltage linear range	V_{OUTR}	-	0.5	-	4.5	V
Output voltage	V_{OUT}	-	$V_{OFF} + S \times I_P / 1000$			V
Noise	V_N	DC to 1 MHz	-	25	-	mV _{PP}
Dynamic Performance						
Step response time	t_R	90% of I_{PN}	-	1	-	μs
Delay time	t_D	500 kHz Sine	-	0.5	-	μs
Bandwidth	BW	-3 dB	-	500	-	kHz

7. TMR7307-20C Individual Electrical Characteristics

$T_A = 25\text{ }^\circ\text{C}$, $V_{CC} = 5\text{ V}$, $CV_{CC} = 0.1\text{ }\mu\text{F}$, $N_P = 1$ turn, Unless otherwise specified

Parameter	Symbol	Conditions	Min.	Typ.	Max.	Unit
Nominal Performance						
Primary nominal current	I_{PN}	TMR7307-20C	-	20	-	A
Primary measuring current range	I_{PM}	TMR7307-20C	-20	-	20	A
Sensitivity	S	TMR7307-20C	-	100	-	mV/A
Offset voltage	V_{OFF}	TMR7307-20C	2.48	2.5	2.52	V
Accuracy Performance						
Accuracy	X_G	$T_A = 25\text{ }^\circ\text{C}$	-1	-	1	% I_{PN}
		$T_A = -40\text{ }^\circ\text{C to }105\text{ }^\circ\text{C}$	-2.5	-	2.5	% I_{PN}
Linearity	ϵ_L	-	-	0.5	1	% I_{PN}
Magnetic hysteresis voltage	V_{OH}	@ $I_P = 0\text{ A}$ after $\pm I_{PM}$	-20	-	20	mV

8. TMR7307-25C Individual Electrical Characteristics

$T_A = 25\text{ }^\circ\text{C}$, $V_{CC} = 5\text{ V}$, $CV_{CC} = 0.1\text{ }\mu\text{F}$, $N_p = 1\text{ turn}$, Unless otherwise specified

Parameter	Symbol	Conditions	Min.	Typ.	Max.	Unit
Nominal Performance						
Primary nominal current	I_{PN}	TMR7307-25C	-	25	-	A
Primary measuring current range	I_{PM}	TMR7307-25C	-25	-	25	A
Sensitivity	S	TMR7307-25C	-	80	-	mV/A
Offset voltage	V_{OFF}	TMR7307-25C	2.48	2.5	2.52	V
Accuracy Performance						
Accuracy	X_G	$T_A = 25\text{ }^\circ\text{C}$	-1	-	1	% I_{PN}
		$T_A = -40\text{ }^\circ\text{C to } 105\text{ }^\circ\text{C}$	-2.5	-	2.5	% I_{PN}
Linearity	ϵ_L	-	-	0.5	1	% I_{PN}
Magnetic hysteresis voltage	V_{OH}	@ $I_P = 0\text{ A}$ after $\pm I_{PM}$	-20	-	20	mV

9. TMR7307-32C Individual Electrical Characteristics

$T_A = 25\text{ }^\circ\text{C}$, $V_{CC} = 5\text{ V}$, $CV_{CC} = 0.1\text{ }\mu\text{F}$, $N_p = 1\text{ turn}$, Unless otherwise specified

Parameter	Symbol	Conditions	Min.	Typ.	Max.	Unit
Nominal Performance						
Primary nominal current	I_{PN}	TMR7307-32C	-	32	-	A
Primary measuring current range	I_{PM}	TMR7307-32C	-32	-	32	A
Sensitivity	S	TMR7307-32C	-	62.5	-	mV/A
Offset voltage	V_{OFF}	TMR7307-32C	2.48	2.5	2.52	V
Accuracy Performance						
Accuracy	X_G	$T_A = 25\text{ }^\circ\text{C}$	-1	-	1	% I_{PN}
		$T_A = -40\text{ }^\circ\text{C to } 105\text{ }^\circ\text{C}$	-2.5	-	2.5	% I_{PN}
Linearity	ϵ_L	-	-	0.5	1	% I_{PN}
Magnetic hysteresis voltage	V_{OH}	@ $I_P = 0\text{ A}$ after $\pm I_{PM}$	-20	-	20	mV

10. TMR7307-40C Individual Electrical Characteristics

$T_A = 25\text{ }^\circ\text{C}$, $V_{CC} = 5\text{ V}$, $CV_{CC} = 0.1\text{ }\mu\text{F}$, $N_p = 1$ turn, Unless otherwise specified

Parameter	Symbol	Conditions	Min.	Typ.	Max.	Unit
Nominal Performance						
Primary nominal current	I_{PN}	TMR7307-40C	-	40	-	A
Primary measuring current range	I_{PM}	TMR7307-40C	-40	-	40	A
Sensitivity	S	TMR7307-40C	-	50	-	mV/A
Offset voltage	V_{OFF}	TMR7307-40C	2.48	2.5	2.52	V
Accuracy Performance						
Accuracy	X_G	$T_A = 25\text{ }^\circ\text{C}$	-1	-	1	% I_{PN}
		$T_A = -40\text{ }^\circ\text{C to } 105\text{ }^\circ\text{C}$	-2.5	-	2.5	% I_{PN}
Linearity	ϵ_L	-	-	0.5	1	% I_{PN}
Magnetic hysteresis voltage	V_{OH}	@ $I_P = 0\text{ A}$ after $\pm I_{PM}$	-20	-	20	mV

11. TMR7307-50C Individual Electrical Characteristics

$T_A = 25\text{ }^\circ\text{C}$, $V_{CC} = 5\text{ V}$, $CV_{CC} = 0.1\text{ }\mu\text{F}$, $N_p = 1$ turn, Unless otherwise specified

Parameter	Symbol	Conditions	Min.	Typ.	Max.	Unit
Nominal Performance						
Primary nominal current	I_{PN}	TMR7307-50C	-	50	-	A
Primary measuring current range	I_{PM}	TMR7307-50C	-50	-	50	A
Sensitivity	S	TMR7307-50C	-	40	-	mV/A
Offset voltage	V_{OFF}	TMR7307-50C	2.48	2.5	2.52	V
Accuracy Performance						
Accuracy	X_G	$T_A = 25\text{ }^\circ\text{C}$	-1	-	1	% I_{PN}
		$T_A = -40\text{ }^\circ\text{C to } 105\text{ }^\circ\text{C}$	-2.5	-	2.5	% I_{PN}
Linearity	ϵ_L	-	-	0.5	1	% I_{PN}
Magnetic hysteresis voltage	V_{OH}	@ $I_P = 0\text{ A}$ after $\pm I_{PM}$	-20	-	20	mV

12. Typical Characteristics

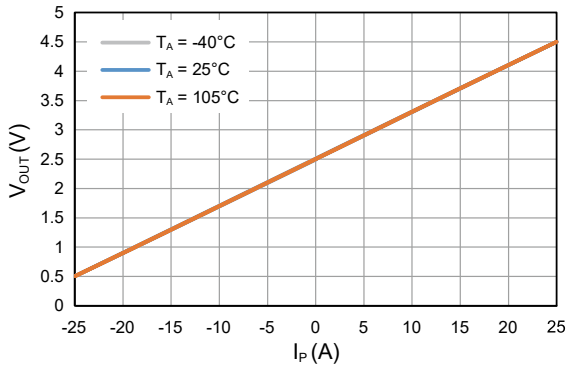

Figure 3. Output Voltage vs Primary Current

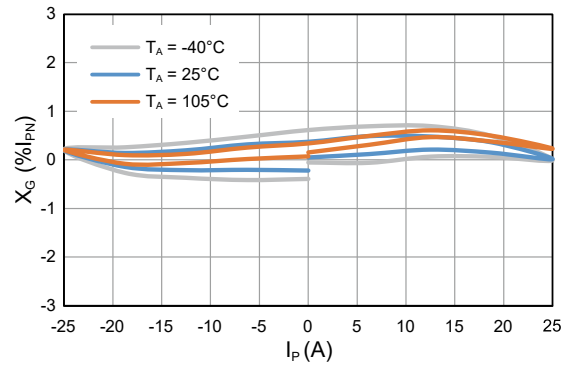

Figure 4. Accuracy vs Primary Current

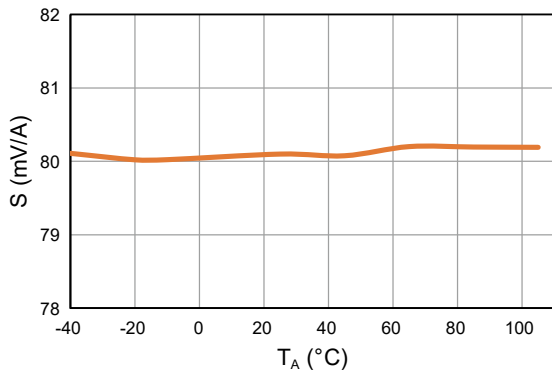

Figure 5. Sensitivity vs Ambient Temperature

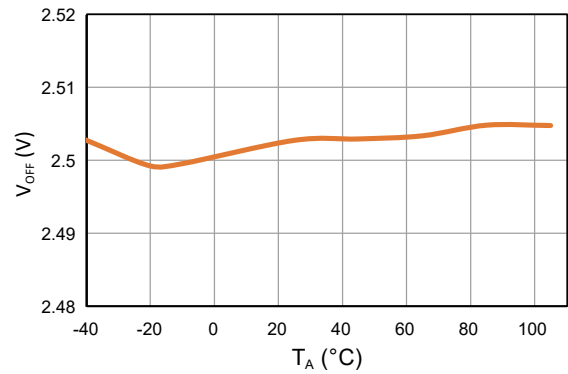

Figure 6. Offset Voltage vs Ambient Temperature

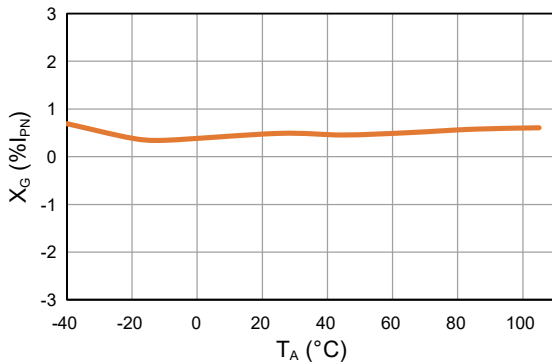

Figure 7. Accuracy vs Ambient Temperature

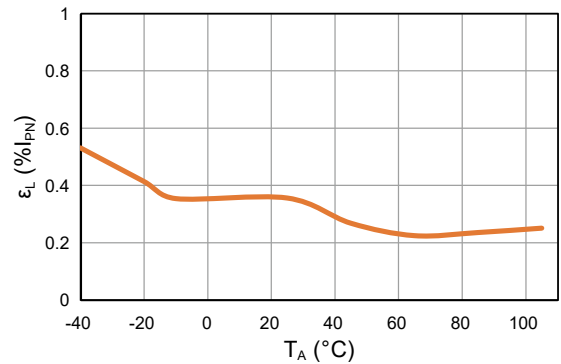

Figure 8. Linearity Error vs Ambient Temperature

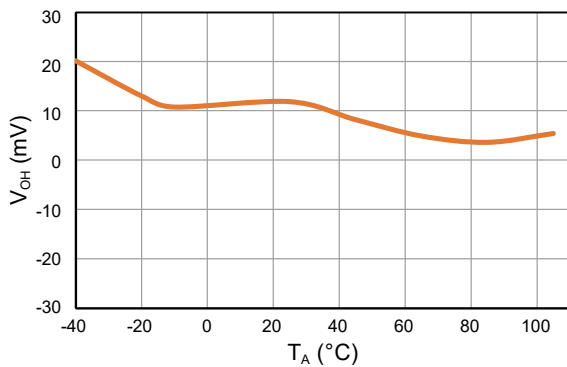

Figure 9. Magnetic Hysteresis Voltage vs Ambient Temperature

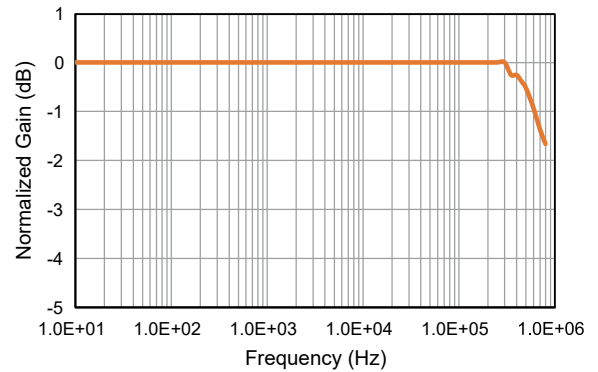

Figure 10. Frequency Response

13. Parameters Definition And Formula

1) Output Voltage

$$V_{OUT} = V_{OFF} + S \times I_P$$

V_{OFF} is the offset voltage at $I_P = 0A$, S stands for sensitivity, I_P stands for primary current, the output voltage V_{OUT} is proportional to the primary current I_P .

2) Accuracy

$$X_G = \text{MAX}_{I_P \in [-I_{PN}, I_{PN}]} \left(\frac{V_{OUT} - (S \times I_P)}{S \times I_{PN}} \times 100\% \right)$$

I_{PN} stands for nominal primary current

3) Sensitivity

$$S = \frac{V_{OUT(@ I_{PN})} - V_{OUT(@ -I_{PN})}}{2 \times I_{PN}}$$

$V_{OUT(@ I_{PN})}$ and $V_{OUT(@ -I_{PN})}$ stand for the voltage output at I_{PN} and $-I_{PN}$ respectively.

4) Linearity

$$\varepsilon_L = \text{MAX}_{I_P \in [-I_{PN}, I_{PN}]} \left(\frac{V_{OUT} - (\bar{V}_{OFF} + \bar{S} \times I_P)}{S \times I_{PN}} \times 100\% \right)$$

\bar{S} and \bar{V}_{OFF} stand for the linear fit values of the sensitivity and the offset voltage.

5) Hysteresis

$$V_{OH} = \text{MAX } \Delta H$$

V_{OH} is the output voltage deviation at $I_P = 0A$ after a cycle of positive and negative measuring current.

14. Dimensions

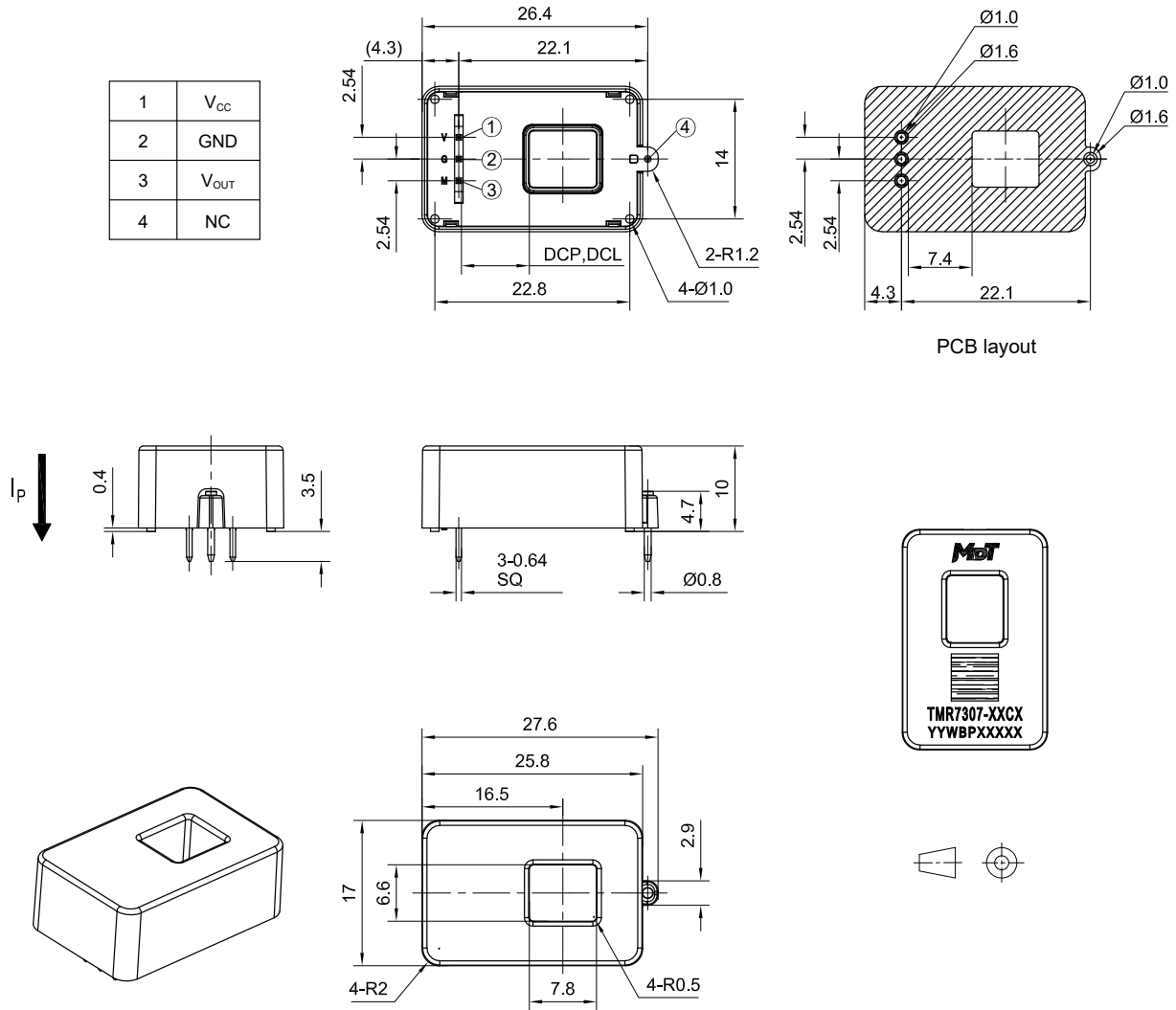

Figure 11. Dimension (unit: mm, tolerances for unmarked scales ±0.5 mm)

15. Caution for Using

- 1) The product contains magnetic core to ensure that the product can avoid damage during transportation and handling.
- 2) Store the product in appropriate temperature and low enough humidity, and use within 4 weeks after the opening the packaging.
- 3) Keep the product away from chlorine or corrosive gas, it may affect the performance of the product.
- 4) Check the solderability of the products that have been stored for a long time; For storage exceeding a year, it is recommended to store in a nitrogen environment.
- 5) During wave soldering, ensure that the pin temperature is within T_{LEAD} temperature and the soldering time is not over 10 seconds.
- 6) Using the product under non-rated electrical specifications will cause damage or abnormality, such as exceeding the rated voltage or current of the specification.
- 7) Interference sources such as the current, magnetic field, or electric field near the product may change the product characteristics. Ensure that the installation position is correct.

Copyright © 2025 by MultiDimension Technology Co., Ltd.

Information furnished herein by MultiDimension Technology Co., Ltd. (hereinafter MDT) is believed to be accurate and reliable. However, MDT disclaims any and all warranties and liabilities of any kind, with respect to any examples, hints or any performance or use of technical data as described herein and/or any information regarding the application of the product, including without limitation warranties of non-infringement of intellectual property rights of any third party. This document neither conveys nor implies any license under patent or other industrial or intellectual property rights. Customer or any third-party must further determine the suitability of the MDT products for its applications to avoid the applications default of customer or third-party. MDT accept no liability in this respect.

MDT does not assume any liabilities of any indirect, incidental, punitive, special or consequential damages (including without limitation of lost profits, lost savings, business interruption, costs related to the removal or replacement of any products or rework charges) whether or not such damages are based on tort (including negligence), warranty, breach of contract or any other legal theory. Notwithstanding any damages that customer might incur for any reason whatsoever, MDT's aggregate and cumulative liability towards customer for the products described herein shall be limited in accordance with the terms and conditions of commercial sale of MDT.

Absolute maximum ratings are the extreme limits the device will withstand without damage to the MDT product. However, the electrical and mechanical characteristics are not guaranteed as the maximum limits (above recommended operating conditions) are approached. MDT disclaims any and all warranties and liabilities of the MDT product will operate at absolute maximum ratings.

Specifications may change without notice.

Please download latest document from our official website www.dowaytech.com/en.

Recycling

The product(s) in this document need to be handed over to a qualified solid waste management services company for recycling in accordance with relevant regulations on waste classification after the end of the product(s) life.



No.2 Guangdong Road, Zhangjiagang Free Trade Zone, Jiangsu, China

Web: www.dowaytech.com/en E-mail: info@dowaytech.com

